



Thank You for purchasing the

IND-5000BT

1-DIN DVD/CD RECEIVER WITH 3.5" LCD



**USER MANUAL
V1.0**

Bravo View Technology
20153 Paseo Del Prado
Walnut, CA 91789
United States of America
909-869-0699
www.bravoview.com

Safety Precautions

Thank you for purchasing this product. Please read through these operating instructions so you will know how to operate your model properly. After you have finished reading the instructions, keep this manual in a safe place for future reference.

Only connect the unit to a 12-volt power supply with negative grounding.

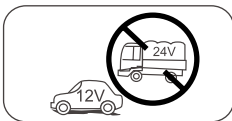

Never install this unit where the operation & condition for safety driving is restrained.

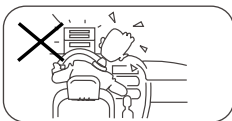

Never use the video display function in the front when driving to prevent the violation of laws & regulations and also to reduce the risk of traffic accident except using for rear view video camera.



To ensure safe driving, please adjust the volume to a safe & comfortable level in case of emergency situations.

Never expose this unit, amplifier, and speakers to moisture or water for preventing electric sparks or fires.



Please don't change the fuse on the power cord without professional guidance, using improper fuse may cause damage to this unit or even cause fire.

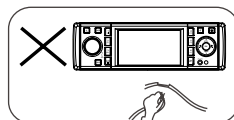

Please power off this unit at once and send it back to the after-sales service center or the dealer/distributor you purchased from if one of the following symptoms is found:

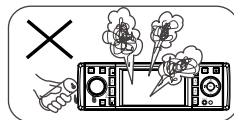

- (a). No audio output;
- (b). No image output;
- (c). Water or other obstacle enters the unit;
- (d). Smoking;
- (e). Peculiar smell.

To provide a clear demonstration and an alternative for easy understanding of the operation of this unit, graphic illustration was used. However, this illustration is not necessary printed as the actual image found on the unit.

Safety Information

Caution

This product is a CLASS 1 LASER PRODUCT. Use of controls or adjustments or performance of procedures other than those specified herein may result in hazardous radiation exposure. Do not open covers and do not repair yourself. Refer servicing to qualified personnel.

Two Laser Products

Wave length: CD: 780nm DVD: 650nm

Laser power: No hazardous radiation is emitted with safety protection.

To reduce the risk of fire electric shock, and annoying interference, use only the included components.

Caution of Disc Using

1. Never insert a 3-inch (8cm) CD contained in the adapter or an irregularly shaped CD. The unit may not be able to eject it, resulting in a malfunction.

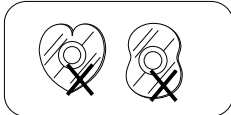

2. Disc Cleaning. Use a dry, soft cloth to wipe the disc from center to edge, only neutral detergent can be used.

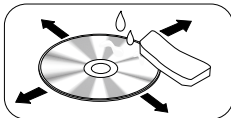

3. When playing a new disc. New disc may have some rough spots around the inner and outer edges. If such a disc is used, remove these rough spots with a pencil or ball-point pen, etc.

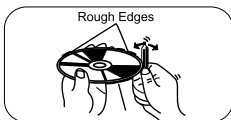

Contents

Safety Precautions	1
Safety Information	2
Features	3
Panel Controls.....	4
Remote Controls	5
USB/SD/MMC/MP3 Playback	6
Basic Operation.....	7
Rotary Knob Menu	8-11
Radio Mode	12
Disc Mode	13-16
BT Mode.....	17-19
Device Connections	20-22
Installation Guide.....	22-24
Anti-Theft System.....	24
Troubleshooting.....	25
Care and Maintainance.....	26
Specifications	27

Features

DVD-R/RW Compatibility

It is possible to playback DVD-R/RW discs recorded with the video format and Video Recording format.

Video CDs Featuring PBC

Compatibility

It is possible to playback Video CDs featuring PBC (playback control).

WMA and MP3 Compatibility

It is possible to playback WMA and MP3 files.

About WMA

This unit can playback WMA data. Windows Media and the Windows logo are trade marks or registered trademarks of Microsoft Corporation in the United States and/or other countries.

This unit may not operate correctly depending on the application used to encode WMA files.

About MP3

Supply of this product only conveys a license for private, non-commercial use and does not convey a license nor imply any right to use

this product in any commercial (i.e. revenue-generating) realtime broadcasting (terrestrial, satellite, cable and/or any other media), broad-casting/streaming via internet, intranets and/or other networks or in other electronic content distribution systems, such as pay-audio or audio-on-dem and applications. An independent license for such use is required. For de-tails, please visit <http://www.mp3licensing.com>.

Button Operation Explanations

Some frequent operations

1. Move cursor

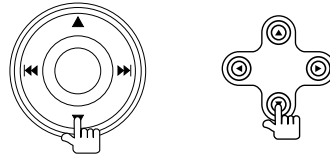

In Setting mode, rotating the **VOL** knob has the same function as the **▲ / ▼** button to select setting items.

2. Confirm



Press the **▲** button on the panel to open the panel.

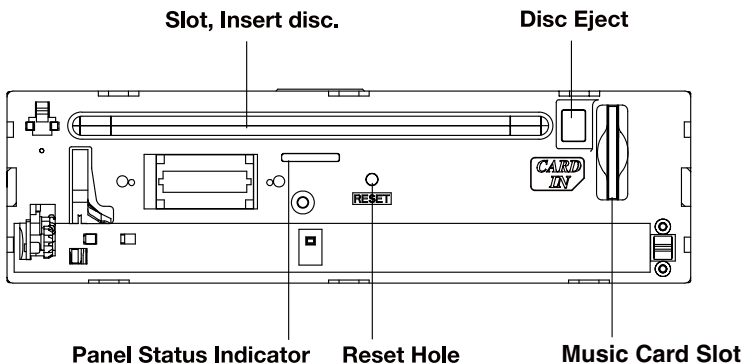

Panel Controls

Power on/off: Press  to turn on/off the unit.

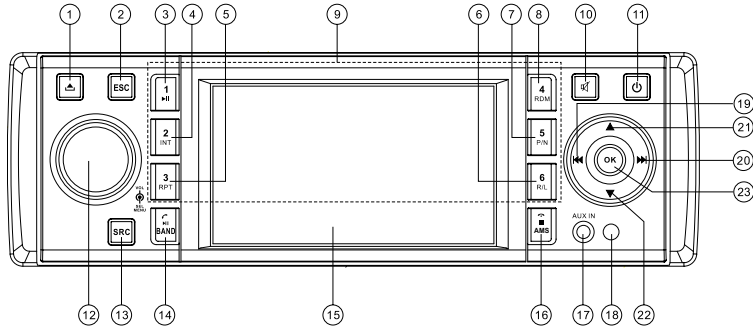

1. Panel open
2. Return to previous menu
3. Button 1: Play/Pause
4. Button 2: Intro play
5. Button 3: Track repeat play
6. Button 6: - DVD audio channel
- VCD audio channel L/R/ST
7. Button 5: Video system PAL/NTSC/AUTO
8. Button 4: Track random play
9. Button 1~6: Radio preset: Press to listen to a preset station, and hold for more than 2 seconds to store station.
11. Power on/off
12. - Rotate the knob to adjust volume level
- Press to select Audio/Video setting, and rotate the knob to adjust level.
- Press more than 2 seconds to enter Setting menu.
13. Select playing mode:
 - Radio
 - Disc (when disc inserted)
 - USB (when USB inserted)
 - SD (when SD/MMC inserted)
 - AV 1 (rear audio/video input. External peripheral devices with RCA audio and video outputs can be connected with the unit.)
 - AV 2 (front audio/video input)
 - BT
 - Long press to return to main source menu in any mode, then use navigate button to select the desired mode, and press the **VOL** button to confirm.
14. - Band switch: FM1-FM2-FM3-AM1-AM2 (in Radio mode)
- Play/Pause (in DVD, CD and MP3/WMA modes)
- Dial/Receive call (press briefly, in BT mode)
15. 3.5 inch TFT display
16. - AMS: Auto preset (press more than 2 seconds)/Preset scan (press briefly, in Radio mode)
- Stop (in CD, MP3/WMA, and DVD video mode)
- Terminate call (in BT mode)
17. AUX IN (3.5mm audio/video input)
18. Remote sensor
19. - Previous track (in CD, MP3/WMA, and DVD video mode)
- Fast backwards (press and hold more than 2 seconds, in CD, MP3/WMA and DVD video mode)
- Tuning backwards (press briefly to tune automatically, press and hold more than 2 seconds to tune manually, in Radio mode)
20. - Next track (in CD, MP3/WMA, and DVD video mode)
- Fast forwards (press and hold more than 2 seconds, in CD, MP3/WMA and DVD video mode)
- Tuning forwards (press briefly to tune automatically, press and hold more than 2 seconds to tune manually, in Radio mode)
21. - Press to navigate up among option items (in DVD, CD and MP3/WMA modes)
- Play the previous preset radio station (in Radio mode)
22. - Press to navigate down among option items (in DVD, CD and MP3/WMA modes)
- Play the next preset radio station (in Radio mode)
23. - Confirm operation (in Setting mode)
- Stop auto seeking (in Radio mode)

Remote Controls

Press  to turn on/off the unit.

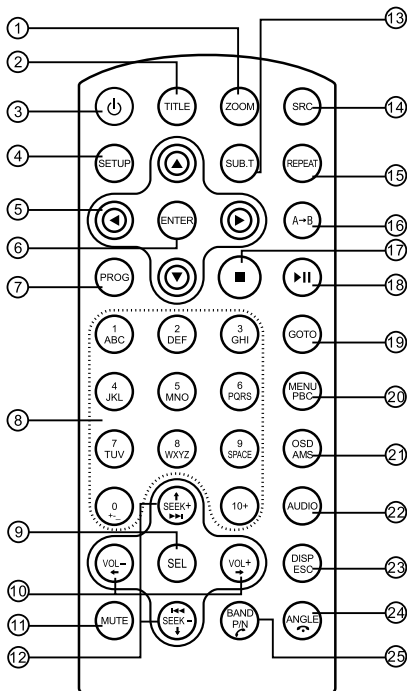

1. Zoom (DVD/VCD only)
2. Title (DVD only)
3. Power on/off
4. Setup
5. Menu cursor
6. Enter
7. Program
8. Digit area
9. Select Audio/Video Setting, then rotate the knob to adjust level.
10. Volume
11. Mute
12. - Radio tune
 - Track skip/seek
13. Subtitle (DVD only)
14. Source switch
15. Repeat
16. Repeat A-B
17. Stop/Return
18. Play/Pause
19. Goto search
20. - DVD menu
 - PBC (for VCD 2.0 or up)
21. - OSD: On screen display

- AMS: Search and store stations automatically
- 22. - DVD audio
- VCD audio L/R/ST
- 23. - Display time/clock (Video mode)
- Return to previous menu
- 24. - Angle (DVD only)
- Terminate call (in BT mode)
- 25. - Video system PAL/NTSC/AUTO
- Radio band (in Radio mode)
- Dial/Receive call (in BT mode)

Remote Control Operating Range

The remote control can operate within a distance of 3~5m.

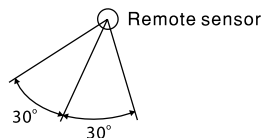

Replacing the lithium battery

When the range of operation of the card remote control becomes short or no function, replace the lithium battery with a new one. Make sure the battery polarity replacement is correct.

1. Pull out the battery holder while pressing the stopper.
2. Insert the button-type lithium battery with the (+) mark facing upward. Insert the battery holder into the remote control.

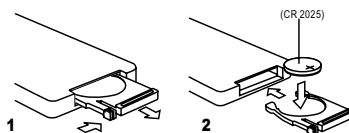

Warning

- Store the battery where children cannot reach. If a child accidentally swallows the battery, consult a doctor immediately.
- Do not recharge, short, disassemble or heat the battery or dispose it in a fire.
- Do not leave the battery with other metallic materials. Otherwise, the battery may start to give off heat, crack or catch fire.
- When throwing away or saving the battery, wrap it in tape and insulate.

USB/SD/MMC/MP3 Playback

1. Load SD/MMC Card

Insert the SD/MMC card into the slot, with the front side at right.

The unit will play the music automatically and the LCD will show CARD.

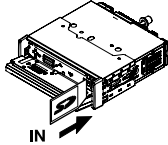

2. Take out SD/MMC Card

Press **SRC** button and switch to non CARD mode, slightly press SD/MMC card, take out the card when it pops out.

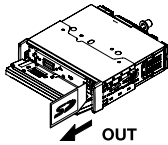

3. Load USB Equipment

Open the rubber cap, insert the USB into the connector and the unit will play the music in the

USB storer automatically, and the LCD will show USB.

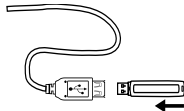

4. Take out USB Equipment

Press **SRC** button and switch to non USB mode, then take off the USB stick, close the rubber cap.

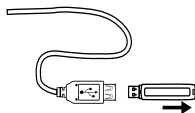

USB/SD/MMC Notes

USB functions (flash memory type) MP3 music play

1. SD/MMC card support
2. USB flash memory 2 in 1 (SD/MMC) support
3. FAT 12/FAT 16, FAT 32 is possible
 - FAT 12/16 (dir: 200 support, file: 500 support)
 - FAT 32 (dir: 200 support, file: 500 support)
4. Tag (id3 tag ver 2.0)
 - Title/artist/album: 30 byte support
5. Multi card reader not support
6. USB 1.1 support
USB 2.0 support
(it can not support USB 2.0 speed. Just, get the same speed with USB 1.1)





Note:

Not all kinds of USB devices are compatible with the unit.

Basic Operations

Turn on/off the Power

1. Press  to turn on the unit.
The unit goes back to the last status after power on.
2. Press  again to power off.

Mute

When power on, press  to cut the sound.



Note:

- Doing the operation above again or adjusting volume will release muting.
- Mute icon appears on the TFT during muting.

Adjust the Volume

Rotate the knob on the panel or press VOL +/- on the remote control to increase or decrease the volume.

The adjustable range of volume is 0 to 39.

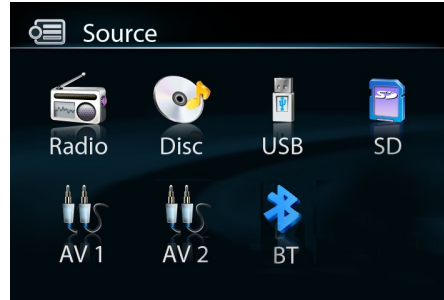
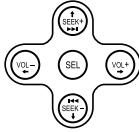
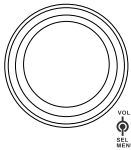

Note:

- When some devices are not ready, they cannot be selected.
- You should stop switching when the playing source you desired has been selected and wait for some seconds, the unit will auto enter the playing source mode you have selected.

When Reverse Driving

If the rear view video camera is connected, the unit automatically switches to CAMERA source during reverse driving. The unit returns to the original work mode after the reverse driving is done.

Playing Source Selection

Method 1

Short press the **SRC** button on the panel or remote control to cycle through all the available sources.

Method 2

In any mode, long press the **SRC** button on the panel or remote control to enter main source menu, then use navigate button to select the desired mode, and press the **OK** button to confirm.



Rotary Knob Menu

1. Rotate the knob to adjust volume level.
2. Short press to access the Audio&VIDEO Setting menu.

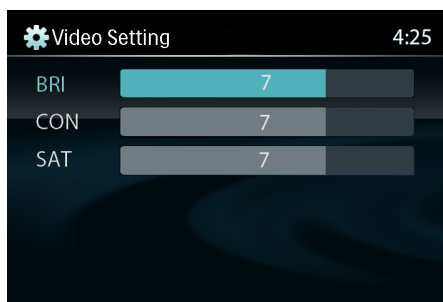
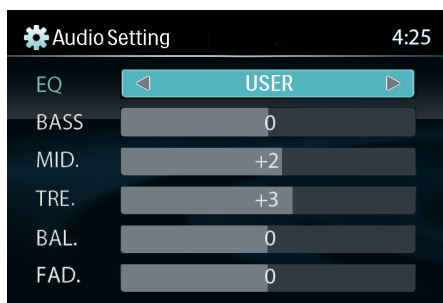

Each press the knob to change the AUDIO mode: EQ/Bass/Middle/Treble/Balance/Fader, and rotate the knob to adjust level.

Each press the knob to change the VIDEO mode: Bright/Contrast/Saturation, and rotate the knob to adjust level.

EQ: USER/FLAT/POP/ROCK/CLASSIC/JAZZ

The Equalizer function applies preset sound effects to the unit's audio output signal. Turn the rotary encoder to select from the following equalizer options: USER, FLAT, POPULAR, ROCK, CLASSIC, JAZZ. With the equalizer function activated, if bass or treble is adjusted, the EQ Mode will revert to "USER". When the equalizer function is activated, the most recently selected bass/treble levels cannot be adjusted. When the equalizer function is not active, the unit will return to the most recently selected bass and treble levels.

3. Press the knob more than 2 seconds to enter Setting mode, then Use ◀/▶, ▲/▼ and OK key to select setting items.

General Setting



BEEP: ON/ OFF

The beep tone feature allows the selection of an audible beep tone to be heard each time the menu is accessed.

LOUDNESS: ON/OFF

When listening to music at low volumes, this feature will selectively boost certain bass and treble frequencies.

TIME MODE

12 HOUR MODE: the clock displays in the type of 12 hours such as 11:18 AM.

24 HOUR MODE: the clock displays in the type of 24 hours such as 20:18.

TIME ADJUST

Press ◀/▶ or ▲/▼ key to set hour and minute. Each time you press ◀/▶ to select one segment of the clock display:

Hour-Minute

As you select segments of the clock display the segment selected will be highlighted. Then you can press ▲/▼ to put a clock right.

PARKING: ON/OFF

When it is in Parking "On" mode, if you play the video disc, the screen will show "WARNING: Engage Parking Brake to View Video".

MIRROR: ON/OFF

This option allows for selection of a mirror image view when a rear view backup camera

Rotary Knob Menu

(sold separately) is connected to the CAMERA IN input on the back of the radio. Turn the rotary encoder to select "On" or "Off".

SUBWOOFER: ON/80HZ/120HZ/160HZ

After connecting a subwoofer to the back of the unit, press ▲ / ▼ key to select a crossover frequency: OFF, 80, 120 or 160Hz.

SUB VOLUME: 0-33

Press ▲ / ▼ key to select the desired subwoofer out volume level.

DVD Setting

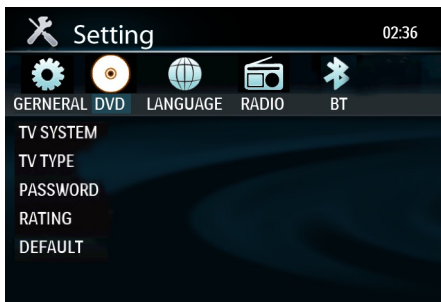

TV SYSTEM: NTSC/PAL/AUTO

Select the TV system in the setting menu.

TV TYPE: 4:3PS/4:3LB/16:9

Select TV type to watch wide screen movies.
4:3 Pan Scan: For 4:3 TV, left and right edges will be cut.
4:3 Letter Box: For 4:3 TV, black bars will appear on top and bottom.
16:9: For 16:9 wide screen TV.

PASSWORD

1. Press number button " 0000 " on the remote control, then press the **ENTER** button to confirm.
2. Press the desired 4-digit password, and then press **ENTER** button to confirm.
3. Record the password and keep it in a safe place for future reference.

**If you forget the password, please enter 0000 to reset a new password.
The password : 0000**

**RATING: 1 KID SAFE/2 G/3 PG/4 PG13/5
PG-R/6 R/7 NC-17/8 ADULT**

The rating of the disc is from 1 to 8:
(1) with the most limits when playing.
(8) with the least limits when playing.
Original setting: 8

Note:

The rating can be selected only under the password unlocked status, and the limits can be worked only under the password locked status.

DEFAULT: RESTORE

If this item is selected, the unit will return to original setting.

BRIGHTNESS

Set the brightness of the video output with ▲/▼ from 00 to 16.

CONTRAST

Set the contrast of the video output with ▲/▼ from 00 to 16.

HUE

Set the hue of the video output with ▲/▼ from 00 to 16.

SATURATION

Set the saturation of the video output with ▲/▼ from 00 to 16.

Rotary Knob Menu

LANGUAGE Setting



OSD LANGUAGE:

Select one language that you are familiar with to display system menu.

AUDIO LANG:

Select one dialogue language that you are familiar with when playing back DVD discs.



Note:

If the DVD disc has the audio file in the selected language, the dialogues you listened to will be in the selected language.

If the DVD disc does not contain the audio file in the selected language, the dialogues you listened to will be in the default language.

You can change the language by pressing [AUDIO] key of the remote controller.

SUBTITLE LANG:

Select one language that you are familiar with to display DVD subtitles.

If the DVD disc has the subtitle file in the selected language, the subtitle will be displayed in the selected language.

If the DVD disc does not contain the subtitle file in the selected language, the subtitle will be displayed in the default language.

MENU LANG:

Select one language that you are familiar with to display DVD menu.



Note:

If the DVD disc has the selected language,

the DVD MENU/TITLE will be displayed in the selected language.

If the DVD disc does not contain the selected language, the DVD MENU/TITLE will be displayed in the default language.

Radio Setting

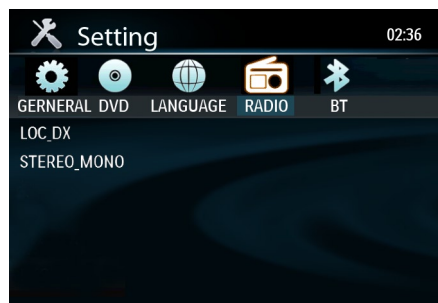

LOC_DX: LOC/DX

Choose radio distant or local.

DX: Stations with strong and weak signals can be broadcast.

LOCAL: Only station with strong signal can be broadcast.

STEREO_MONO: STEREO/MONO

Choose FM mono/stereo.

Rotary Knob Menu

BT Setting

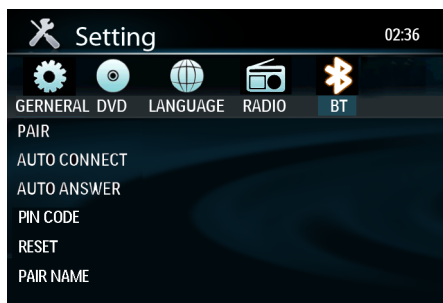

PAIR: ON/OFF

Set pairing ON/OFF. If select ON, to return to BT main menu.

AUTO CONNECT: ON/OFF

After disconnecting with your mobile phone, the built-in bluetooth will send connection order automatically in 20s if you have set the 'AUTO CONNECT' to 'ON'.

AUTO ANSWER: ON/OFF

The built-in bluetooth changes the work mode to phone mode automatically and displays the calling number when one call is coming in. The built-in bluetooth will put through the call automatically if you have set the 'AUTO ANSWER' option to 'ON', whereas you should put through the call manually.

PIN CODE

The default pin code is "1234". If you want to set a new pin code, please input the desired 4-digit password by pressing the number button on the remote control, and then press **ENTER** button to confirm.

RESET: ON

If the Bluetooth function is abnormal, or you forget the pin code, when RESET ON is selected, the Bluetooth system will be cleared and return to default setting, and the pin code also changed to "1234".

PAIR NAME

Display the BT device name: IND-5000BT.

Radio Mode

Accessing Radio Mode

Press the **SRC** button on the front panel or remote control to switch to the Radio source.

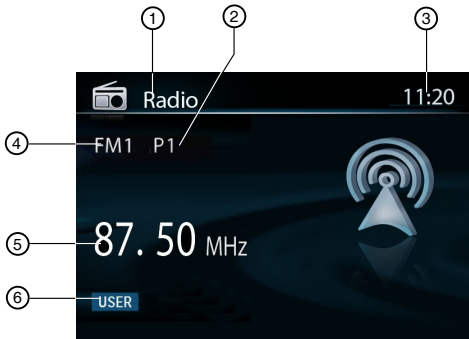

1. Source Indicator
2. Current Preset Channels
3. Time/Clock
4. AM/FM Band
5. Radio Station Frequency
6. EQ Indicator

Selecting a Band

Press **BAND** once or more to select FM1 - FM2 - FM3 - AM1 - AM2.

Display shows wave band, frequency, and preset station number if already stored.

Selecting a Station

Press the **▶▶** or **◀◀** tuning button to tune to another station.

Tuning

- AUTO SEEK

Press the **▶▶** or **◀◀** buttons to seek the next/previous station automatically.

- MANUAL SEEK

Press and hold the **▶▶** or **◀◀** buttons to enter manual tuning mode. Press the buttons again to move the radio frequency number up or down one step.



Note:

During manual seeking, if the pause between two operating steps is longer than 5 seconds, press the **▶▶** or **◀◀** buttons, the unit will enter auto seeking.

Preset Mode

Six numbered preset buttons store and recall stations for each band. The stored stations (P1-P6) for the current band can be viewed on the screen.

Storing Stations

- Auto storing

1. Select a band (if needed).
2. Press **AMS** briefly to scan the preset station P1 - P6 for 5 seconds each.
3. Hold **AMS** more than 2 seconds, the 6 strongest available stations will be automatically saved in the preset button (numbers 1-6).

- Manual Storing

1. Select a band (if needed), then select a station.
2. Press and hold a preset button (numbers 1-6) on the front panel or remote control.
3. The preset number and station is displayed and highlighted.

Recalling a Station

1. Select a band (if needed).
2. Press a front panel or remote control preset button (numbers 1-6) to select the corresponding stored station.

Disc Mode

Accessing Disc Mode

If a disc is already in the disc slot but is not playing, press the **SRC** button on the front panel or on the remote control to switch to the DISC source. To play files from an SD or USB that is already inserted, choose the CARD or USB source. The disc playback screen is indicated below:

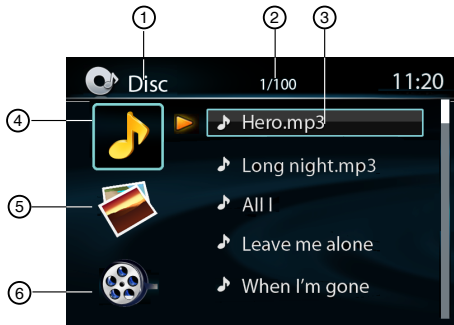

1. Source Indicator
2. Current Track/Total Track
3. Name of the Song Display
4. Audio Folder
5. Picture Folder
6. Video Folder

Insert a Disc

Press **▲** to flip down the panel. Insert the disc into the slot, and the unit will change to disc mode automatically.



Note:

- Please confirm whether there is a disc in the unit before you insert another one.
- The unit will exit current playing source and enter DVD mode when one disc is inserted.

Eject the Disc

Press **▲** to flip down the panel. Press **▲** to eject the disc.



Note:

- After ejecting the disc, the unit reverts to radio mode.
- You can eject a disc with the unit powered off. The unit remains off after the disc is ejected.

Disc Playback

1. When disc inserted, display shows LOAD. For MP3 or disc with mixed files, reading time may exceed 1 minute.

2. ERROR will be displayed if error found in disc operation.
3. For VCD/CD, VCD or CD icon will appear on the display.
4. While MP3/WMA files playback, MP3/WMA icon will appear on the display.
5. For DVD, DVD icon will appear on the display and TITLE appears. Press **ENTER** or **▶** to play.

File Type Supported

Audio file: MP3(*.mp3), WMA(*.wma)

Video file:

MP4 (*.avi, XVID)

MPEG 2 (*.vob)

MPEG 1 (*.dat)

Picture file: JPEG (*.jpg)

MP3 file:

ISO 9660 or ISO 9660 + Joliet format - Max. 30 characters.

Max. nested directory is 8 levels.

The max. album number is 99.

The max. length of each track is 99 minutes 59 seconds.

Supported sampling frequency for MP3 disc: 8KHz to 48KHz (44.1KHz preferably).

Supported bit-rates of MP3 disc are: 32 - 320 kbps (128 kbps preferably).

Disc Mode

Disc and File NOT Supported

*.AAC, *.DLF, *.M3U, *.PLS, MP3 PRO files and files with DRM.

Open session discs.

Audio/Picture/Video File Playback

When AUDIO/PICTURE/VIDEO file is played, Category/Folder/File list will be displayed on the screen, and file/folder name being played will be displayed on top. Current selected item will be highlighted.

The list lets you see the list of track titles or folder names on a disc. If you select a folder on the list, you can view its contents.

For Audio Files

1. Press **ESC** to return to playlist menu.
2. Use **▲ / ▼** to select  AUDIO folders.
3. Press **OK**, **▶||** on the front panel or **ENTER** on the remote control to display all available audio file folders.
4. Use **◀ / ▶** to enter file list and use **▲ / ▼** to select desired file, press **OK**, **▶||** on the front panel or **ENTER** on the remote control to start play.
5. During the file playing, press **■** will enter power on logo, then press **▶||** to return.

For Picture files

1. Press **ESC** to return to playlist menu.
2. Use **▲ / ▼** to select  PICTURE folders.
3. Press **OK**, **▶||** on the front panel or **ENTER** on the remote control to display all available picture file folders.
4. Use **◀ / ▶** to enter file list and use **▲ / ▼** to select desired file, press **OK**, **▶||** on the front panel or **ENTER** on the remote control to slide show the pictures, and press **PROG** to select picture showing style.
5. During the file playing, press **■** to stop and return to the sub-root.

For Video files

1. Press **ESC** to return to playlist menu.
2. Use **▲ / ▼** to select  VIDEO folders.
3. Press **OK**, **▶||** on the front panel or **ENTER** on the remote control to display all available video file folders.
4. Use **◀ / ▶** to enter file list and use **▲ / ▼** to select desired file, press **OK**, **▶||** on the

front panel or **ENTER** on the remote control to start play.

5. During the file playing, press **■** to stop and return to the sub-root.

Note:

1. If the selected folder does not contain any playable track, the track list is not displayed.
2. During the folder selecting, press **ESC** to the upper folder (parent folder). If the uppermost folder is listed, **ESC** cannot be used.

MP3/WMA Notes

MP3 and WMA (Windows Media Audio) music files are digital audio files that are compressed to allow more files to be stored. This unit can play MP3/WMA and video directly from files contained on a CD-R/RW, DVD-ROM, DVD+RW, DVD-RW, DVD+R, DVD-R and DVD-VIDEO, or an SD card or USB Device. Many types of software are available for converting audio files into MP3/WMA formats. Nero or Roxio Easy CD Creator are recommended. This unit can play MP3 (MPEG1, 2, 2.5 Audio Layer 3). However, the MP3 recording media and accepted formats are limited.

Entering ID3 Tag

This unit supports ID3 tag version 2.0.

For character codes, refer to the table to the below.

	0	1	2	3	4	5	6	7	8	9	A	B	C	D	E	F
0				0	@	P	·	p			°	Á	À	à	á	ä
1		!	1	A	Q	a	q				±	Ã	Ñ	ã	ñ	
2		"	2	B	R	b	r				²	Ä	Ö	ä	ö	
3		#	3	C	S	c	s				£	³	Å	Ö	å	ó
4		\$	4	D	T	d	t				¤	´	Á	Ö	á	ó
5		%	5	E	U	e	u				¥	µ	À	Ö	à	ö
6		&	6	F	V	f	v				¶	¶	Æ	Ø	æ	ø
7		'	7	G	W	g	w				§	·	Ç	×	ç	÷
8		(8	H	X	h	x				¨	†	É	Ø	é	ø
9)	9	I	Y	i	y				©	¹	É	Ü	é	ü
A		*	:	J	Z	j	z				ª	ª	Ê	Ü	ê	ü
B		+	:	K	[k	{				«	»	Ê	Ü	ê	ü
C		,	<	L	\	l					¼	½	Ï	Ü	ï	ü
D		-	=	M]	m	}				¾	¾	Ï	ÿ	ï	ÿ
E		.	>	N	^	n	~				¾	¾	Ï	ÿ	ï	ÿ
F		/	?	O	_	o	~				¸	¸	Ï	ÿ	ï	ÿ

Entering File and Folder Names

Names using the code list characters are the

Disc Mode

only file names and folder names that can be entered and displayed. Using any other character will cause the file and folder names to be displayed incorrectly. The unit recognizes and plays only files with the MP3/WMA extension.



Note:

A file name entered with characters not on the code list may not play correctly.

MP3 Playing Order

When selected for play, files and folders (Folder Search, File Search or Folder Select) are accessed in the order in which they were written to the media. As a result, the order in which they are expected to be played may not match the order in which they are actually played. You may be able to set the order in which MP3/WMA files are to be played by assigning file names beginning with play sequence numbers such as "01" to "99". For example, a medium with the following folder/file hierarchy is subject to Folder Search, File Search or Folder Select as shown below.

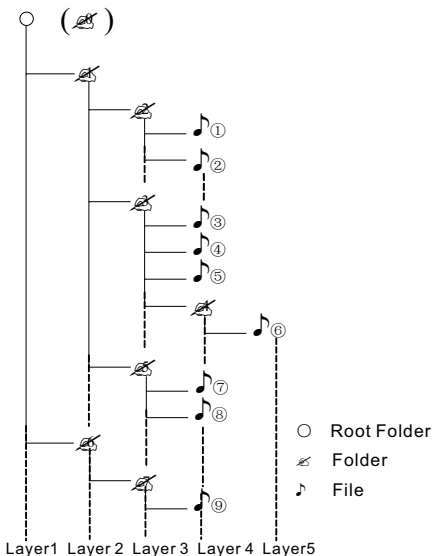

The player will only recognize three folder levels and does not display folders containing only other folders. In the example above, the unit will display folders 3, 4, 6, and 8, but not 2

and 7 since they do not contain since they do not contain any tracks directly. Folder 5 is not recognized at all since it is at the fourth level.

Electronic Shock Protection

- 10 seconds for CD-DA (CDA)
- >45 seconds for MP3 recorded at 44.1kHz, 128kbps
- >90 seconds for WMA recorded at 44.1kHz, 128kbps

Stop Playback Temporarily

- During playback, press **▶||** to pause playback.
 - The sound will be muted.
 - Display "PAUSE" in the TV screen. Press **▶||** again to continue playback.
- To resume normal play, repeat the operation.

Stop Playback Entirely

During DVD, VCD, CD, MP3 playback:

1. Press **■** key once stopping the playback and the relevant location on the disc is saved, press **▶||** to resume the playback from the saved disc location.
2. Press **■** twice to cease the playback. Press **▶||** to start the playback from the very beginning the Title page of the DVD or the first track of VCD / CD.

Select Desired Track

- Press **◀◀** or **▶▶** to skip to the next track.
- Use 1-9 and 0, 10+ buttons on the remote control to select desired track number.

Fast Forward/Backward During Playback

Press **◀◀** or **▶▶** for more than 2 seconds once or more to select X2, X4, X8, X20, to fast backward or forward track during playback.

- During the fast forward or backward operation, press **▶||** briefly to playback again.
- During the fast forward or backward operation, the volume will be muted.

Repeat

During playback, press **REPEAT** once or more.

Disc Mode

- RPT icon will appear on the display.
- For VCD/CD: Display appears RPT ONE → RPT ALL → RPT OFF
- For DVD: Display appears RPT CHAPTER → RPT TITLE → RPT OFF
- For File disc: Display appears RPT ONE → RPT DIR → RPT ALL → RPT OFF



Note:

If you do not select RPT on, when the entire disc or TITLE playback has finished, the system will stop. If no other control, after 5 minutes the unit will turn into standby mode.

Repeat A → B

Select desired passage to repeat playback.

- Press **A** → **B** once to select starting point. Display shows REPEAT A.
- Press **A** → **B** again to select ending point. Display shows REPEAT A → B, and selected passage start to replay.
- Press **A** → **B** once again to exit. Display shows A → B CANCEL.

PBC - Playback Control (for VCD only)

1. If you insert a VCD with PBC, playback starts from the beginning of the 1st track automatically.
2. Press **PBC** to show menu, use **◀◀ / ▶▶** or digit button to select desired track. Press **■** to stop. Press **PBC** again to exit menu.

GOTO

Goto desired track/chapter or time point directly.

Press **GOTO** button on the remote control, track or DVD Title/Chapter and time display on top of the screen. Current item is highlighted. Use **◀ / ▶** to select desired item. Use digit button to select number. Press **ENTER** to confirm.

Program

- Press **PROG** to enter program list. Use **▲ / ▼** or **◀ / ▶** cursor and digit button to enter number.
For DVD and File disc, select title and

chapter number.

For VCD and CD, select track number.

- Press **▶▶** to play, or move the cursor to select "PLAY" and press **ENTER** to play.
- If you want to delete the list, move the cursor to "CLEAR", press **ENTER** to delete all the list set before.
- Press **PROG** again to exit program play.

DVD Audio Select

Press **AUDIO** or **R/L** to select audio language to listen if the DVD has multiple audio languages.

VCD Audio Select

Press **R/L** to select audio channel to listen.

L → R → Stereo



DVD Subtitle Select

Press **SUB.T** to select the subtitle language to show if the DVD has multiple language subtitles.

DVD Title Select

Press **TITLE** to display title or chapter list, use cursor or digit number to select, press **ENTER** to play.

DVD Angle Select

Press **ANGLE** to select different angle to view if the DVD has multiple-angle views.

Picture Mirror

When you view a picture, press **▲** repeatedly to mirror the picture vertically, and press **▼** repeatedly to mirror the picture horizontally.

ZOOM

Press **ZOOM** button, the picture will be zoomed accordingly.

X2 → X3 → X4 → X1/2 → X1/3 → X1/4 → OFF



Bluetooth Mode

Accessing Bluetooth Mode

Press the **SRC** button on the front panel or remote control to switch to the Bluetooth source.

Note:

For your safety, avoid talking on the phone as much as possible while driving.

Bluetooth is a wireless transmission way for short distance. The built-in Bluetooth can connect with the mobile phones having Bluetooth function.

After connecting, you can control your mobile phone through the unit.

Pairing

Use this function to establish a connection between the unit and your mobile phone.

Press the knob more than 2 seconds to enter Setting mode, then Use ◀/▶ key to select BT setting item, and use ▲/▼, ◀/▶ key to switch the PAIR: ON/OFF options to ON.

Press **ESC** to return to Bluetooth main menu. "WAITING FOR PAIRING" will appear on the screen.

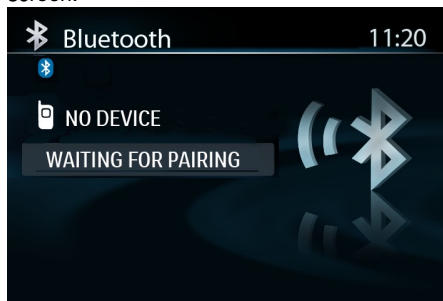

Turn on Bluetooth function of your mobile phone, keep phone within 3 meters to the unit and start to search for Bluetooth devices.



After the name of the Bluetooth module appears on the pairing list on your mobile phone, you should select it. At this time, a pairing code is required. Enter the pairing code ("1234" by default) and the Bluetooth pairing will process automatically. Some mobile phones may instruct you to select connecting or disconnecting, please select connecting.

Stop Pairing



You can stop pairing or disconnecting in this following way:

Enter BT Setting menu, switch the PAIR: ON/OFF options to OFF, then press **ESC** to return to Bluetooth main menu. After disconnecting, "NO DEVICE" will appear on the screen and the Bluetooth icon will disappear.

Incoming Phone Waiting (if the mobile phone has this function depending on the type of mobile phone)

In the mode of communication or BT AUDIO (MUSIC PLAYING), if there is a call coming in, the TFT screen will appear "PHONE NUMBER ANSWER?". If you press  key to stop communication you are making, and receiving the incoming phone. If you press  key on to reject the incoming call, and resume the former communication.



Voice Transfer

During talking, press  key to transfer audio from the unit to your mobile phone, and press  key again to transfer audio from your mobile phone to the unit.

Note:

Some mobile phones will transfer audio from the unit to themselves once the incoming call is answered.

BT Audio (if the mobile phone has the A2DP & AVRCP functions)

After pairing successfully, in the mode of Bluetooth main menu, open the audio player of your mobile phone and set the transmit mode to Bluetooth. At this time, the unit screen will appear "MUSIC PLAYING", and the audio will be transferred from the mobile phone to the unit. Some mobile phones may instruct to connect with the unit. After found the Bluetooth device name on mobile phone, you should select to connect it, and then input the pairing code ("1234" by default). When music playback, you can press  on the remote control to switch to play/pause, and press the  key on the front panel and

Bluetooth Mode



remote control (if the options are available).

LOG



After pairing successfully, in the mode of Bluetooth main menu, press  key to select dialling history.





1. Missed Call

Making a phone call using missed call history.
Press  /  button to search for desired record on the list.

2. Dialed Call

Making a phone call using the dialed number history.
Press  /  button to search for desired record on the list.

3. Received Call

Making a phone call using the received call history.
Press  /  button to search for desired record on the list.

Music Mode

A2DP

A2DP is short for Advanced Audio Distribution Profile. The mobile phones supporting this function can transmit stereo audio, whereas the ones not supporting this function can transmit mono audio only.

AVRCP

AVRCP is short for Audio/Video Remote Control Profile. The mobile phones supporting this function can control the playback of a Bluetooth audio player.

In the mode of the music player working, if you want to make a phone call, you can press the number keys on the mobile phone or on the remote control, then press  to dial. At the same time the music player will stop. The TFT screen will appear "DIALLING", after the call received, the voice will be transferred to the unit. When the call ends, the TFT screen will appear "MUSIC PLAYING". Some mobile phone may instruct whether resume to playback.

If there is an incoming phone call, the music player will stop, and the TFT screen will appear "PHONE NUMBER ANSWER?". When the call ends, the TFT screen will appear "MUSIC PLAYER". Some mobile phone may instruct whether resume to playback.

Bluetooth Mode

General Notes for Bluetooth

1. For N7X, N9X, PHILIPS, Sony Ericsson, SAMSUNG mobile phones, during our test, after the mobile phones appear connection successful, the unit still appear waiting for pairing. At this time you must find the unit's Bluetooth module name on the pairing list of your mobile phone and select it. In the submenu, select connecting, then the unit will appear pair OK. Otherwise, there is no voice coming out when communicating, though the mobile phone has already displayed pair OK. Some mobile phones, such as PHILIPS, when it playbacks A2DP, you must in its playbacks mode, find the unit's Bluetooth module name and reconnect (check your mobile phone whether has the A2DP & AVRCP functions).
2. When pairing, some types of mobile phone can instruct you how to operate, for example, when you make a phone call with the unit, but no voice comes out, it is because the mobile phone voice doesn't be transferred to the unit. The SAMSUNG mobile phone can instruct voice should be transferred to Bluetooth device.
3. Depending on the mobile phone, if private mode is selected, when you make a phone call with the unit, when received, the voice can be transferred to the mobile phone. But sometime the Bluetooth maybe disconnect till the communication ends, and connects your mobile phone and the unit automatically. Some mobile phones maybe require you to perform again the pairing operation.
4. For mobile phone, the Bluetooth device name must be primary symbols or numbers. Otherwise, some unpredictable issues may occur during the Bluetooth devices connecting and making phone call.
5. After paired OK, if no sound produced, please check the Bluetooth stereo audio whether is switched to ON.

Device Connections

Notes of connection

- To avoid short circuit in the electrical system, ensure that the negative battery cable is disconnected before installation.
- To prevent short circuit in the wiring and damaging to this unit, secure all wirings with cable clamp or adhesive tape. Route the wirings in a secured, out of heating place without touching any moving parts such as gear shift, handbrake, and seat rails to prevent the wiring insulation being melted / wore off.
- Never pass the yellow power cord through the installation hole into the engine compartment and connect to the car battery. Otherwise, a high possibility of serious short circuit to the electrical system may be occurred.
- Replacing a new fuse with 15A rating when the old one is broken, using no fuse or fuse with improper rating may cause damage to this unit or even fires.

- If a proper fuse is installed and electrical problems still occur, please contact with any professional car shops for inquiry.
- **DO NOT** connect other equipments with the car battery to avoid battery overheating.
- Please make sure all the wiring connections & the cables of the Speakers are well-insulated. Otherwise, this unit may be damaged by short circuit.
- If there is no ACC available, please connect ACC lead to the power supply with a switch.
- If an external power amplifier is connected, please don't connect P.CONT lead to the power lead of the external power amplifier, otherwise, electric spark or other damage may be resulted.
- Never ground the speaker output to prevent the damage to the built-in power amplifier.
- The minimum rating of the speakers connected to this unit is 50W with 4 to 8 impedance.

Parking Brake Cable Connections

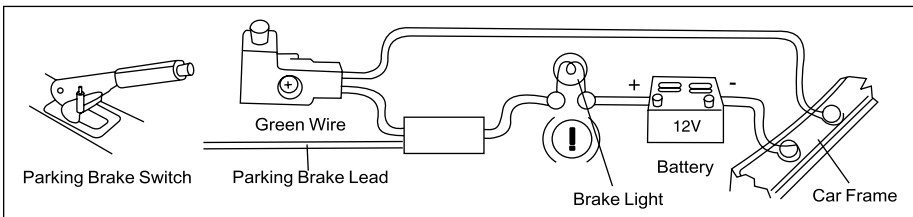

Reverse Driving Cable Connections

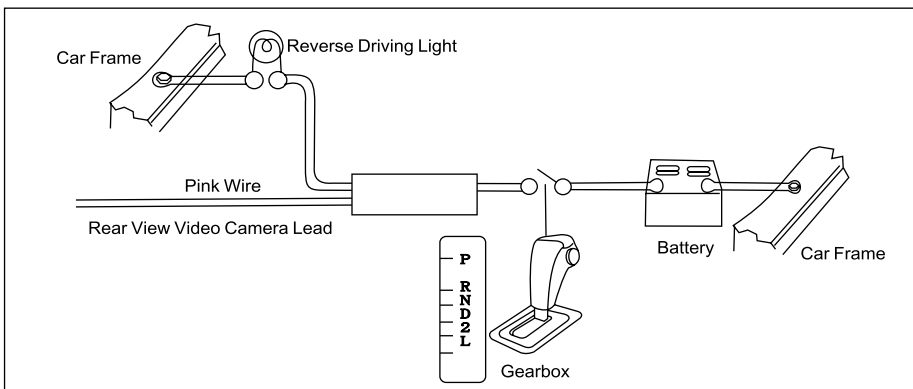

Device Connections

Wiring Diagram

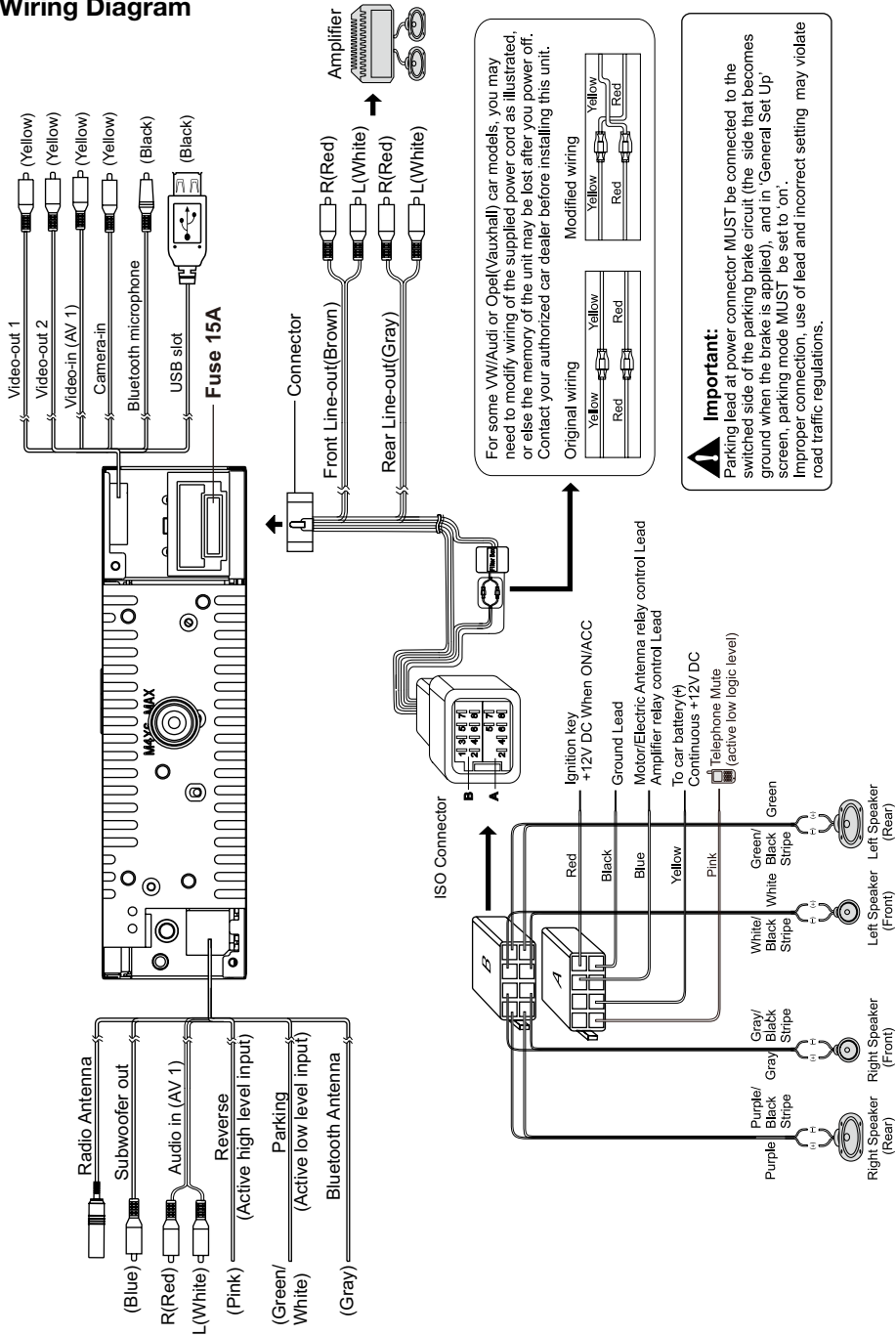

Device Connections

Using the ISO Connector

1. If your car is equipped with the ISO connector, then connect the ISO connectors as illustrated.
2. For connections without the ISO connectors, check the wiring in the vehicle carefully before connecting, incorrect connection may cause serious damage to this unit.

Cut the connector, connect the colored leads of the power cord to the car battery, as shown in the colour code table below for speaker and power cable connections.

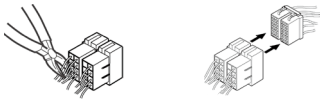

Location	Function	
	Connector A	Connector B
1		Rear Right (+) - Purple
2	Telephone Mute/Pink	Rear Right (-) - Purple / Black Stripe
3		Front Right (+) - Gray
4	Battery 12V(+)/Yellow	Front Right (-) - Gray / Black Stripe
5	ANT/Amp control /Blue	Front Left(+) - White
6		Front Left(-) - White / Black Stripe
7	ACC+/Red	Rear Left (+) - Green
8	Ground/Black	Rear Left (-) - Green/ Black Stripe

Installation Guide

Preparation

1. Disconnect battery

Before you begin, always disconnect the battery negative terminal.

Note:

If the unit is to be installed in a car equipped with an on-board drive or navigation computer, do not disconnect the battery cable. If the cable is disconnected, the computer memory may be lost. Under these conditions, use extra caution during installation to avoid causing a short circuit.

2. Remove transport screws



IMPORTANT:

Remove these two transport screws before installation. Otherwise, the DVD player will not work.

3. Remove unit from sleeve

Lift latches on both sides of sleeve to remove half-sleeve from the unit.

Mounting Sleeve Installation

1. Slide the mounting sleeve off the chassis. If it is locked into position, use the removal tools (supplied) to disengage it.
2. Check the dashboard opening size by sliding the mounting sleeve into it.



If the opening is too small, carefully cut or file as necessary until the sleeve easily slides into the opening. Do not force the sleeve into the opening or cause it to bend or bow. Check for sufficient space behind the dashboard for the unit chassis.

This unit can be installed in any dashboard with a suitable 183 mm (W) x 52 mm (H) opening as shown above. The dashboard should be 4.75 mm - 5.56 mm thick in order to be able to support the unit.

3. Locate the series of bend tabs along the top, bottom, and sides of the mounting

Installation Guide

sleeve. With the sleeve fully inserted into the dashboard opening, bend as many of the tabs outward as necessary to firmly secure the sleeve to the dashboard.

CAUTION:

For proper operation of the DVD player, the chassis must be mounted within 20° of horizontal. Make sure the unit is mounted within this limitation.

4. Place the unit in front of the dashboard opening so the wiring can be brought through the mounting sleeve. Follow the wiring diagram carefully and make certain all connections are secure and insulated with wire nuts or electrical tape. After completing the wiring connections, turn the unit on to confirm operation (vehicle ignition must be on). If the unit does not operate, re-check all wiring until the problem is corrected.
5. Make sure the radio is right-side up, then carefully slide the radio into the mounting sleeve until it is fully seated and the spring clips lock it into place.
6. Secure the rear of the unit to the car body using the mounting bolt and rubber cushion.
7. Test the unit using the "Operation" instructions that follow.

Kit Installation

If your vehicle requires the use of an installation kit to mount this unit, follow the instructions included with the installation kit to attach the unit to the mounting plate supplied with the kit.

1. Wire and test the unit as outlined in the Mounting Sleeve Installation instructions.
2. Install the radio/mounting plate assembly to the sub-dashboard according to the instructions in the installation kit.
3. Replace the dashboard trim panel.

ISO Installation

This unit has threaded holes in the chassis side panels which may be used with the original factory mounting brackets of some vehicles to mount the radio to the dashboard. Please consult with your local car stereo shop for assistance on this type of installation.

1. Remove the existing factory radio from the dashboard or center console mounting. Save all hardware and brackets as they will be used to mount the new radio.
2. Carefully unsnap the plastic frame from the front of the new unit chassis. Remove and discard the frame.
3. Remove the factory mounting brackets and hardware from the existing unit and attach them to the new unit. Do not exceed M5 x 9mm maximum screw size. Longer screws may damage components inside the chassis.

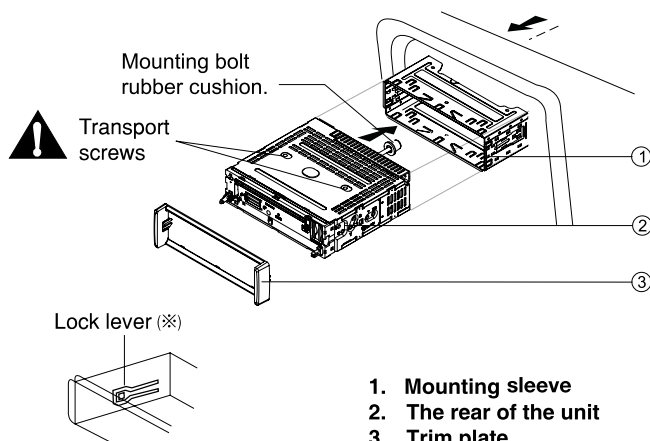

Installation Guide

4. Wire the new unit as outlined in the Mounting Sleeve Installation instructions.
5. Mount the new unit assembly to the dashboard or center console using the reverse procedure of step 1.

Reset

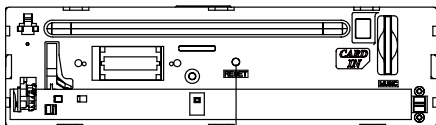

Reset

The **RESET** button is located behind the front panel and can only be accessed with the front panel opened. Resetting the unit will erase the time and preset memories. It should only be activated upon initial installation after all wiring is complete, or if there is a malfunction of any of the switches on the unit. In these circumstances, pressing the **RESET** button will clear the system and return the unit to default operation.

Fuse

When replacing a fuse, make sure the new fuse is the correct type and amperage. Using an incorrect fuse could damage the radio.

Reconnect Battery



When wiring is complete, reconnect the battery negative terminal.

Anti-Theft System

This unit is designed with a flip-down detachable panel.

The panel can be detached and taken with you, helping to deter theft.

Remove the Panel

1. Press  to switch off the power of the unit.
2. Press  to flip down the panel.
3. Grasp the right side to release the front panel and then pull it at an angle to remove the right side from the chassis.
4. Store the front panel in the supplied carrying case to protect it from dirt and damage, and take it with you to prevent theft.

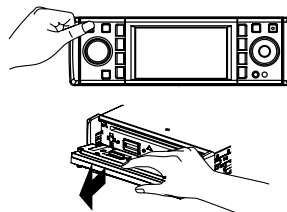

Re-attach the Front Panel

1. With the panel laying flat (in the “open” position), insert the left side of the panel in place until correctly engaged.
2. Gently press the right side of the panel until the mechanism locks it into place.
3. Lift upward to close the panel.

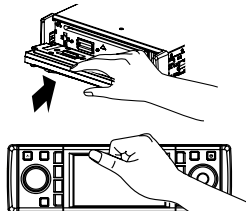

Remove the Unit

1. Remove the panel and the trim plate.
2. Remove the trim ring by firmly grasping one side and pulling.
3. Insert the removal keys straight back until they lock, then pull the radio out. If the removal keys are inserted at an angle, they will not lock properly and will not release the unit.

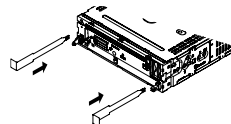

Troubleshooting

If you suspect something is wrong, immediately switch power off. Immediately stop using it and call the store where you purchased it. Never try to repair the unit yourself because it is dangerous to do so.

Problem	Possible cause	Solution
General		
The unit will not switch on.	Car ignition is not on. Cable is not properly connected. Fuse is burnt.	Turn your car key in the ignition. Check cable connection. Replace fuse with a new fuse of the same capacity.
No sound	Volume is set at minimum or the mute function is on.	Check the volume or switch the mute function off.
The unit or screen does not function normally.	The unit system is unstable.	Press the RESET button.
DVD mode		
The appliance will not play discs.	The disc is inserted incorrectly. The disc is dirty or damaged.	Disc must be inserted with the label side facing up. Clean the disc and check for damage. Try another disc.
Sound skips due to vibration.	Mounting angle is over 30°. Mounting is unstable.	Adjust mounting angle to less than 30°. Mount the unit securely with the supplied parts.
TUNER mode		
Unable to receive stations.	The antenna is not connected properly.	Connect the antenna properly.
Poor quality reception of radio station.	The antenna is not fully extended or it is broken.	Fully extend the antenna and if broken, replace it with a new one.
Preset stations are lost.	The battery cable is not properly connected.	Connect the permanent live on the unit to the permanent live on the vehicle.
USB/SD/MMC mode		
Unable to insert USB device or SD/MMC card.	The memory card or USB device has been inserted the wrong way round.	Insert it the other way around.
The USB device or SD/MMC card cannot be read.	NTFS format is not supported.	Check that the USB/SD/MMC file system is in FAT or FAT32 format. Due to different formats, some models of USB storage devices or MP3 players may not be read.
Remote control		
The remote control is not working or does not work properly	The batteries are low or empty.	Change the batteries.

Care and Maintenance

DVD Player

The following guidelines will help you extend the life of your DVD player:

1. When cleaning the vehicle interior, do not get water or cleaning fluids on the unit.
2. The DVD player will not operate properly in extreme hot/cold or under damp conditions. In case of such conditions, wait until the vehicle interior reaches a normal temperature or any condensation on the disc player lens has evaporated before using the player.
3. Always remove the disc when the player is not in use.
4. The unit is designed with a vibration dampening disc mechanism to minimize interruption of disc play due to normal vibration in a moving vehicle. However, occasional sound skips may occur when driving on very rough roads. This will not scratch or damage the disc, and normal play will resume when the rough conditions cease.

CD-R and CD-RW Capability

Depending on media type and method of "recording/burning", some CD-R/RWs may be incompatible with this unit. After "recording/burning", the session must be closed. Please refer to your software's recommended procedures for closing a disc/session. Review your recording software to familiarize yourself with the correct "recording/burning" procedures. We recommend using the latest versions of ROXIOTM or NEROTM burning software.

In addition, this unit will only recognize the CDDA (Compact Disc Digital Audio), .MP3 and .WMA formats "recorded / burned" onto a CD-R/RW. This unit does not support .WAV, .OGG or other formats.

Disc Care and Handling

Dirt, dust, scratches and warpage can cause skips in the playback and deterioration of sound quality. Please follow these guidelines to take care of your compact discs.

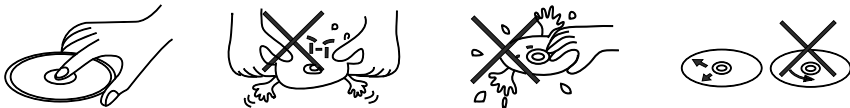

1. Do not touch the disc surface.
2. Never use chemicals such as record sprays or household cleaners to clean discs, as they can irreparably damage the disc's surface.
3. Discs should be kept in their storage cases when not in use.
4. Do not expose discs to direct sunlight, high temperatures or high humidity for long periods.
5. Carefully wipe fingerprints, dust and dirt from the disc's playing surface with a soft cloth. Wipe in a straight motion from the inside to the outside of the disc.
6. Do not stick paper, tape or disc labels on disc surfaces, as internal damage may occur.

Specifications

General

Power supply:	12VDC (11V-16V), Test voltage 14.4V, negative ground
Maximum power output:	45W x 4 channels
Continuous power output:	20W x 4 channels (4Ω 10% T.H.D.)
Suitable speaker impedance:	4-8ohm
Pre-Amp output voltage:	4.0V (CD play mode: 1KHz, 0dB, 10KΩ load)
Fuse:	15A
Dimensions (WxHxD):	178 x 50 x 166mm
Weight:	1.7kg
Aux-in level:	≥500mV
Sub-out:	4.0V (CD play mode: 61Hz, 0dB, 10KΩ load)

3.5 Inch TFT LCD

Display resolution (dot)	320×(RGB)×234
Active area (mm)	76.32 (H)×42.822 (V)
Screen size (inch)	3.5 (16:9)
Dot pitch (mm)	0.2385 (H) x 0.183 (V)
Contrast ratio	350
Brightness	350nits

FM Stereo Radio

Frequency range:	87.5-108.0MHz (Europe) 87.5-107.9MHz (America)
Usable sensitivity:	8dBμ
Frequency response:	30Hz-15KHz
Stereo separation:	30dB(1KHz)
Image response ratio:	50dB
IF response ratio:	70dB
Signal/noise ratio:	>55dB

AM(MW) Radio

Frequency range	522-1620KHz (Europe) 530-1710KHz (America)
Usable sensitivity (S/N=20dB)	30dB

Disc Player

System:	Disc digital audio system
Frequency response:	20Hz - 20KHz
Signal/noise ratio:	>80dB
Total harmonic distortion:	Less than 0.20% (1KHz)
Channel separation:	>60dB
Video signal format system:	PAL/NTSC/AUTO
Video output:	1 ± 0.2V

Components

Mounting sleeve	1
Machine screws M5x6 mm	4
Mounting bolt (50 mm)	1
Wire connector	1
Removable face plate case	1
Trim plate	1
Removal key	2
Operating Instructions	1
Rubber cushion	1
Remote control	1



Note:

Specifications and the design are subject to change without notice due to improvements.

Limited Warranty

Bravo View Technology warrants this product (including any accessory and/or cable) against defects in material or workmanship as follows:

1. Labor. For a period of 1 Year from original date of purchase, if the product is determined to be defective, Bravo View will repair or replace the product at no charge.
2. Parts. For a period of 1 Year from original date of purchase, Bravo View will at no charge, replace with new or rebuilt parts in exchange for defective parts. The warranty will either continue from date of original purchase or 90 days from repair (Whichever is longer).

This warranty does not cover customer misuse, improper installation, poor signal (including any “noise”), cosmetic damage, damage due by accident, abuse, negligence, commercial use, and improper operation.

Proof of Purchase in the form of a copy of a bill of sale or copy of receipted/invoice, which shows clearly the sale of the unit, is required.

Repair or Replacement as provided under this warranty is the exclusive remedy of the consumer. Bravo View Technology shall not be liable for any incidental or consequential damage for breach of any express or implied warranty on this product. In no event shall Bravo View Technology be liable for any incidental or consequential damage whatsoever arising out of the use or inability to use the product. Under no circumstance shall Bravo View Technology's liability exceed the purchase price paid for the product. Except to the extent prohibited by applicable law, any implied warranty or merchantability or fitness for a particular purpose on this product is limited in duration to the duration of this warranty.

PROCESS:

1. Contact Bravo View and describe the problem with the unit. Please have your model number, date of purchase and where it was purchased ready. If requesting on-line, please include your name, address and telephone number.
2. If determined that the item is warrantable, Bravo View will issue a RA# and provide an address to mail the unit back to.
3. Bravo View is not responsible for articles lost or stolen during shipping. IT IS ADVISABLE TO SHIP THE UNIT IN A METHOD IN WHICH YOU CAN TRACK THE PACKAGE, AND POSSIBLY INSURE THE PACKAGE. Bravo View does not cover the expense of mailing the unit back to us.
4. Once Bravo View receives and validates the unit to ensure it is within warranty, Bravo View will replace the unit, fix the unit, or offer a substitute of the unit if a replacement is not available. Bravo View may send a refurbished unit back.
5. Bravo View will mail the unit back to you. To obtain warranty service, you must contact Bravo View Technologies for a Return Authorization Number (RA#), 866-40-BRAVO or visit www.bravoview.com.

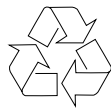
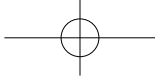

P.N.: 12707500XXXX

